

studio

SETUP GUIDE



YOURS IS HERE

studio

SETUP GUIDE

Model P02E series

Type P02E001

Notes, Cautions, and Warnings

 **NOTE:** A NOTE indicates important information that helps you make better use of your computer.

 **CAUTION:** A CAUTION indicates either potential damage to hardware or loss of data and tells you how to avoid the problem.

 **WARNING:** A WARNING indicates a potential for property damage, personal injury, or death.

Information in this document is subject to change without notice.

© 2009 Dell Inc. All rights reserved.

Reproduction of these materials in any manner whatsoever without the written permission of Dell Inc. is strictly forbidden.

Trademarks used in this text: *Dell*, the *DELL* logo, *YOURS IS HERE*, and *DellConnect* are trademarks of Dell Inc.; *Intel*, *Pentium*, and *Celeron* are registered trademarks and *Core* is a trademark of Intel Corporation in the U.S. and other countries; *Microsoft*, *Windows*, *Windows Vista*, and *Windows Vista* start button logo are either trademarks or registered trademarks of Microsoft Corporation in the United States and/or other countries; *Blu-ray Disc* is a trademark of the Blu-ray Disc Association; *Bluetooth* is a registered trademark owned by Bluetooth SIG, Inc. and is used by Dell under license.

Other trademarks and trade names may be used in this document to refer to either the entities claiming the marks and names or their products. Dell Inc. disclaims any proprietary interest in trademarks and trade names other than its own.

Contents

Setting Up Your Studio Laptop	5	Touch Pad Gestures	28
Before Setting Up Your Computer	5	Media Controls	30
Connect the AC Adapter	6	Display Features	32
Connect the Network Cable (Optional)	7	Using the Touch Screen (Optional)	34
Press the Power Button	8	Removing and Replacing the Battery	38
Set Up Microsoft Windows	9	Software Features	40
Install the SIM (Optional)	10	Free Fall Sensor	44
Enable or Disable Wireless (Optional)	12	Solving Problems	45
Connect to the Internet (Optional)	14	Touch Screen Problems	45
Using Your Studio Laptop	18	Beep Codes	46
Right Side Features	18	Network Problems	47
Left Side Features	22	Power Problems	48
Computer Base and Keyboard		Memory Problems	49
Features	26	Lockups and Software Problems	50

Contents

Using Support Tools	52	Before You Call.....	71
Dell Support Center.....	52	Contacting Dell.....	73
System Messages.....	53	Finding More Information and	
Hardware Troubleshooter.....	55	Resources	74
Dell Diagnostics.....	56	Specifications	76
Restoring Your Operating System	60	Appendix	87
System Restore.....	61	Macrovision Product Notice.....	87
Dell Factory Image Restore.....	62	Index	88
Operating System Reinstallation.....	64		
Getting Help	66		
Technical Support and Customer			
Service.....	67		
DellConnect™.....	67		
Online Services.....	68		
Automated Order-Status Service.....	69		
Product Information.....	69		
Returning Items for Repair Under			
Warranty or for Credit.....	70		

Setting Up Your Studio Laptop

This section provides information about setting up your Studio 1745/1747 laptop.

Before Setting Up Your Computer

When positioning your computer, ensure that you allow easy access to a power source, adequate ventilation, and a level surface to place your computer.

Restricting airflow around your Studio laptop may cause it to overheat. To prevent overheating ensure that you leave at least 10.2 cm (4 inches) at the back of the computer and a minimum of 5.1 cm (2 inches) on all other sides. You should never place your computer in an enclosed space, such as a cabinet or drawer when it is powered on.

 **WARNING:** Do not block, push objects into, or allow dust to accumulate in the air vents. Do not place your Dell™ computer in a low-airflow environment, such as a closed briefcase, while it is powered on. Restricting the airflow can damage the computer or cause a fire. The computer turns on the fan when the computer gets hot. Fan noise is normal and does not indicate a problem with the fan or the computer.

 **CAUTION:** Placing or stacking heavy or sharp objects on the computer may result in permanent damage to the computer.

Connect the AC Adapter

Connect the AC adapter to the computer and then plug it into a wall outlet or surge protector.

⚠ WARNING: The AC adapter works with electrical outlets worldwide. However, power connectors and power strips vary among countries. Using an incompatible cable or improperly connecting the cable to a power strip or electrical outlet may cause fire or permanent damage to your computer.

✍ NOTE: Connect the power cord to the adapter firmly and ensure that the light on the adapter is on when you turn on power.

✍ NOTE: Use only Dell AC adapter family PA-3E, PA-10, and PA-12 with your computer.

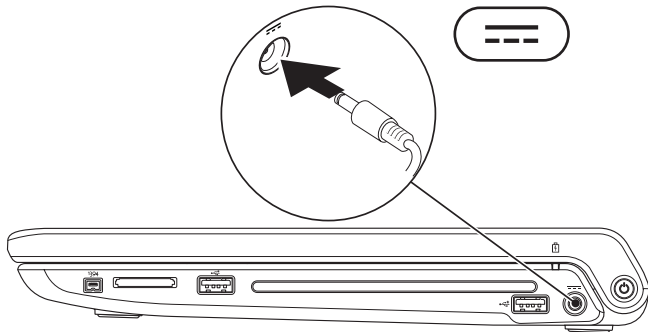

Connect the Network Cable (Optional)

To use a wired network connection, connect the network cable.

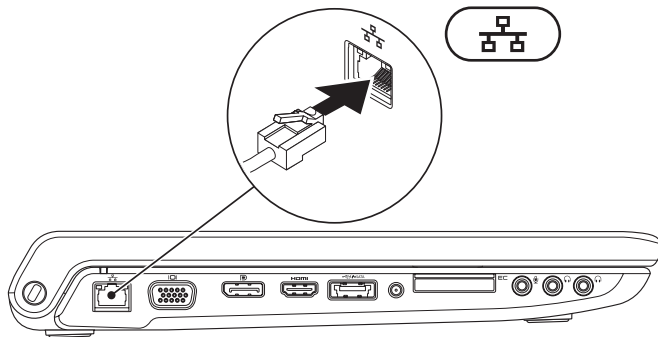

Press the Power Button

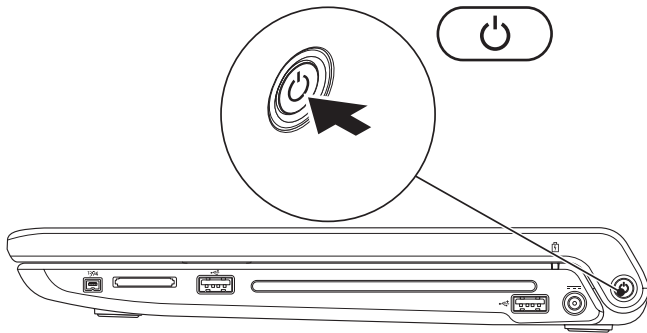

Set Up Microsoft Windows

Your Dell computer is preconfigured with Microsoft® Windows® operating system. To set up Windows for the first time, follow the instructions on the screen. These steps are mandatory and may take some time to complete. The screens will take you through several procedures including accepting license agreements, setting preferences, and setting up an Internet connection.

 **CAUTION:** Do not interrupt the operating system's setup process. Doing so may render your computer unusable and you will need to reinstall the operating system.

 **NOTE:** It is recommended that you download and install the latest BIOS and drivers for your computer available on the Dell Support website at support.dell.com.

Install the SIM (Optional)

Installing a Subscriber Identity Module (SIM) card on your computer allows you to connect to the Internet. To access the Internet you must be within the network of your cellular service provider.

 **NOTE:** Only GSM (HSDPA) type cards need a SIM. EVDO cards do not use a SIM.

To install the SIM:

1. Turn off your computer.
2. Remove the battery (see “Removing and Replacing the Battery” on page 38).
3. In the battery bay, slide the SIM into the SIM card slot.
4. Replace the battery (see “Removing and Replacing the Battery” on page 38).
5. Turn on your computer.

- 1 SIM card
- 2 SIM card slot
- 3 battery bay

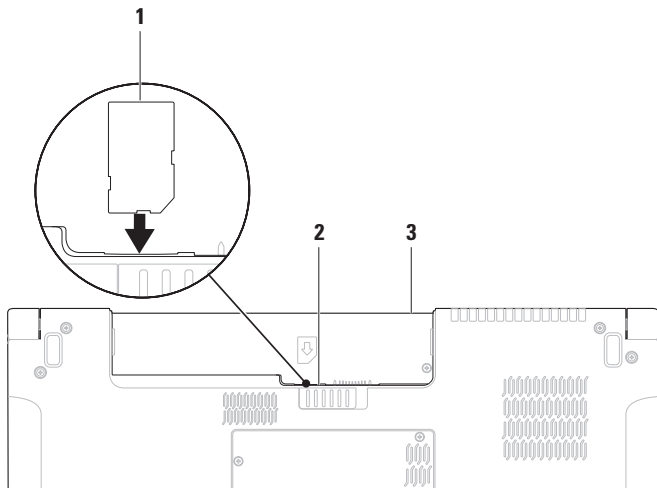

Enable or Disable Wireless (Optional)

Press the $\langle \text{A} \rangle$ key or press the $\langle \text{Fn} \rangle \langle \text{F2} \rangle$ keys on the keyboard to enable or disable wireless. The wireless on or off icons appear on the screen to indicate the status.

Wireless on:

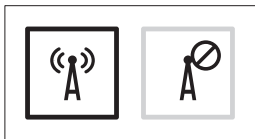

Wireless off:

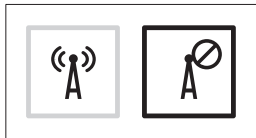

For information on changing the behavior of the Fn key, see “Media Controls” on page 30.

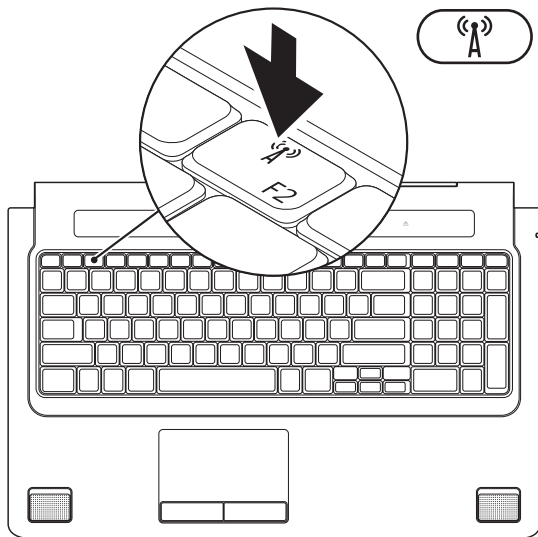

Connect to the Internet (Optional)

To connect to the Internet, you need an external modem or network connection and an Internet Service Provider (ISP).

If an external USB modem or WLAN adapter is not a part of your original order, you can purchase one from the Dell website at www.dell.com.

Setting Up a Wired Connection

- If you are using a dial-up connection, connect the telephone line to the external USB modem (optional) and to the telephone wall connector before you set up your Internet connection.
- If you are using a DSL or cable/satellite modem connection, contact your ISP or cellular telephone service for setup instructions.

To complete setting up your wired internet connection, follow the instructions in “Setting Up Your Internet Connection” on page 16.

Setting Up a Wireless Connection

 **NOTE:** To set up your wireless router, see the documentation that shipped with your router.

Before you can use your wireless Internet connection, you need to connect to your wireless router.

To setup your connection to a wireless router:

Windows Vista[®]

1. Ensure that wireless is enabled on your computer (see “Enable or Disable Wireless” on page 12).
2. Save and close any open files, and exit any open programs.
3. Click **Start**  → **Connect To**.
4. Follow the instructions on the screen to complete the setup.

Windows[®] 7

1. Ensure that wireless is enabled on your computer (see “Enable or Disable Wireless” on page 12).
2. Save and close any open files, and exit any open programs.
3. Click **Start**  → **Control Panel** → **Network and Sharing Center** → **Connect to a network**.
4. Follow the instructions on the screen to complete the setup.

Setting Up Your Internet Connection

ISPs and ISP offerings vary by country. Contact your ISP for offerings available in your country.

If you cannot connect to the Internet but have successfully connected in the past, the Internet Service Provider (ISP) might have a service outage. Contact your ISP to check the service status, or try connecting again later.

Have your ISP information ready. If you do not have an ISP, the **Connect to the Internet** wizard can help you get one.

Windows Vista[®]

 **NOTE:** The following instructions are applicable to the Windows default view, so they may not apply if you set your Dell™ computer to the Windows Classic view.

1. Save and close any open files, and exit any open programs.
2. Click **Start**  → **Control Panel**.
3. Click **Network and Internet** → **Network and Sharing Center** → **Set up a connection or Network** → **Connect to the Internet**.

The **Connect to the Internet** window appears.

 **NOTE:** If you do not know which type of connection to select, click **Help me choose** or contact your ISP.

4. Follow the instructions on the screen and use the setup information provided by your ISP to complete the setup.

Windows® 7

1. Save and close any open files, and exit any open programs.
2. Click **Start**  → **Control Panel** → **Network and Sharing Center** → **Set up a new connection or network** → **Connect to the Internet**.

The **Connect to the Internet** window appears.

-  **NOTE:** If you do not know which type of connection to select, click **Help me choose** or contact your ISP.
3. Follow the instructions on the screen and use the setup information provided by your ISP to complete the setup.

Using Your Studio Laptop

Your Studio 1745/1747 laptop has indicators and buttons that provide information and enable you to perform common tasks. The connectors on your computer provide the option of attaching additional devices.

Right Side Features

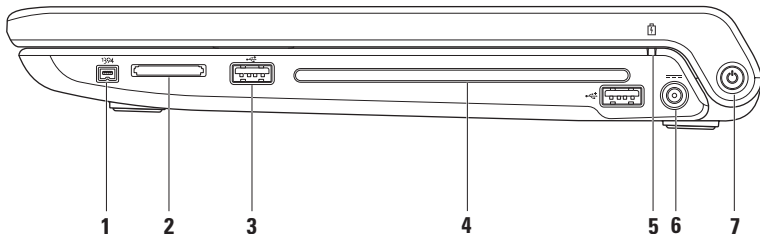

1  **IEEE 1394a connector** – Connects to high-speed serial multimedia devices, such as digital video cameras.

2 **8-in-1 Media Card Reader** – Provides a fast and convenient way to view and share digital photos, music, videos, and documents stored on the following digital memory cards:

- Secure digital (SD) memory card
- Secure Digital Input/Output (SDIO) card
- Secure Digital High Capacity (SDHC)
- Secure Digital High Density (SDHD)
- Memory Stick
- Memory Stick PRO
- MultiMedia Card (MMC)
- xD-Picture Card

NOTE: Your computer ships with a plastic blank installed in the media card slot. Blanks protect unused slots from dust and other particles. Save the blank for use when no media card is installed in the slot; blanks from other computers may not fit your computer.

3  **USB 2.0 connectors (2)** – Connects to USB devices, such as a mouse, keyboard, printer, external drive, or MP3 player.

- 4 Optical drive** – Plays or records CDs, DVDs, Blu-ray Discs (optional). Ensure that the side with print or writing is facing upward when inserting discs.

 **CAUTION:** Do not use non-standard-size or shape discs (including mini-CDs and mini-DVDs) or you will damage the drive.

Place the disc in the center of the disc slot, with the label facing upwards and gently push the disc into the slot. The drive will automatically pull the disc in and begin reading its content.

- 5 Battery status light** – Turns on steadily or blinks to indicate the battery charge status. The light indicates the following states when the computer is powered by

the AC adapter:

- Solid white – the battery is adequately charged.
- Solid amber – the battery charge is low and the battery is charging.

the battery:

- Off – the battery is adequately charged or the computer is turned off.
 - Solid amber – the battery charge is low.
 - Blinking amber – the battery charge is critically low and you should either plug in the AC adapter or save and close your open documents and applications.
-

6  **AC adapter connector** – Connects to the AC adapter to power the computer and charge the battery.

7  **Power button and light** – Turns the computer on or off when pressed.

The light in the button indicates the following power states:

- Solid white – The computer is on.
 - Blinking white – The computer is in standby mode.
 - Off – The computer is off or in hibernate state.
-

Left Side Features

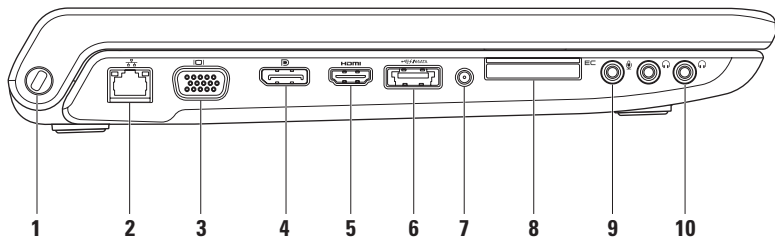

1 Security cable slot – Attaches a commercially available antitheft device to the computer.

NOTE: Before you buy an antitheft device, ensure that it works with the security cable slot on your computer.

2  **Network connector** – Connects your computer to a network or a broadband device if you are using a wired network. The two lights next to the connector indicate status and activity for wired network connection.

3  **VGA connector** – Connects to video devices, such as a monitor or a projector.

4  **DisplayPort connector** – Digital interface standard connector that supports external DisplayPort monitors and projectors.

5  **HDMI connector** – Connects to a TV for both 5.1 audio and video signals.

NOTE: When used with a monitor, only the video signal is read.



- 6**  **eSATA/USB combo connector with USB PowerShare** – Connects to eSATA compatible storage devices (such as external hard disk drives or optical drives) or USB devices (such as a mouse, keyboard, printer, external drive, or MP3 player). The USB Powershare feature allows you to charge USB devices when the computer is powered on/off or in sleep state.

NOTE: Certain USB devices may not charge when the computer is powered off or in sleep state. In such cases, turn on the computer to charge the device.

NOTE: If you turn off your computer while charging an USB device, the device will stop charging. To continue charging, disconnect the USB device and connect it again.

NOTE: The USB PowerShare is automatically shut off when only 10% of the total battery life remains.

-
- 7 Antenna in connector (on supported models)** – Connects to an external antenna to view programs using the TV tuner card (optional).
-

-
- 8  **ExpressCard slot** – Provides support for additional memory, wired and wireless communications, multimedia, and security features. The slot supports 34 mm ExpressCards.
- NOTE:** The ExpressCard slot is designed only for ExpressCards. It does NOT support PC cards.
- NOTE:** Your computer ships with a plastic blank installed in the ExpressCard slot. Blanks protect unused slots from dust and other particles. Save the blank for use when no ExpressCard is installed in the slot; blanks from other computers may not fit your computer.
-
- 9  **Audio in/Microphone connector** – Connects to a microphone or inputs signal for use with audio programs.
-
- 10  **Audio out/Headphone connectors (2)** – Connects one or two pairs of headphones, or sends audio to a powered speaker or sound system. The audio signal is the same for both connectors.
-

Computer Base and Keyboard Features

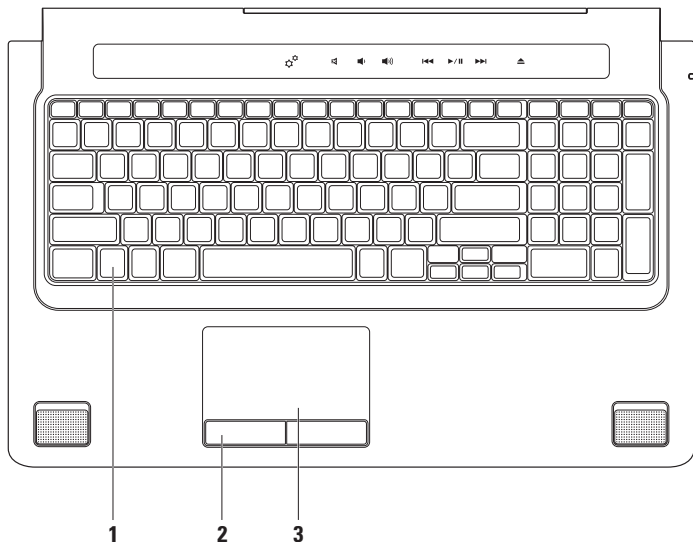

-
- 1 Keyboard/Backlit Keyboard (optional)** – If you have purchased the optional backlit keyboard, the F6 key has the backlit keyboard icon  on it. The optional backlit keyboard provides visibility in dark environments by illuminating all symbols on the keys.

The media controls are also located on the keyboard. These keys control CD, DVD, Blu-ray Disc™ (optional), and media playback.

 **Backlit keyboard brightness settings** – Press the <F6> key to toggle the three lighting states (in the given order):

- a. half keyboard brightness
- b. full keyboard brightness
- c. no lighting

For more information about the keyboard, see the *Dell Technology Guide*.

-
- 2 Touch pad buttons** – Provide left-click and right-click functions like those on a mouse.

-
- 3 Touch pad** – Provides the functionality of a mouse to move the cursor, drag or move selected items, and right-click or left-click by tapping the surface.

The touch pad supports the Scroll, Flick, Zoom, Rotate, and Desktop features. To change the touch pad settings, double-click the **Dell Touch pad** icon in the notification area of the desktop.

Touch Pad Gestures

Scroll

Allows you to scroll through content. The scroll feature includes:

Pan – Allows you to move the focus on the selected object when the entire object is not visible.

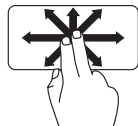

Move two fingers in the desired direction to pan scroll the selected object.

Auto Scroll Vertical – Allows you to scroll up or down on the active window.

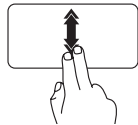

Move two fingers up or down at a fast pace to activate vertical auto scrolling.

Tap on the touch pad to stop auto scrolling.

Auto Scroll Horizontal – Allows you to scroll left or right on the active window.

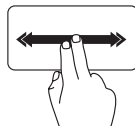

Move two fingers to your left or right at a fast pace to activate horizontal auto scrolling.

Tap on the touch pad to stop auto scrolling.

Flick

Allows you to flip content forward or backward based on the direction of the flick.

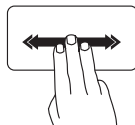

Move three fingers quickly in the desired direction to flip content in the active window.

Zoom

Allows you to increase or decrease the magnification of the screen content. The zoom feature includes:

Pinch – Allows you to zoom in or zoom out by moving two fingers apart or bringing them closer together on the touch pad.

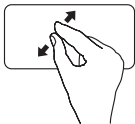

To zoom in: Move two fingers apart to enlarge the view of the active window.

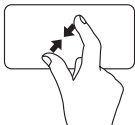

To zoom out: Move two fingers close together to reduce the view of the active window.

Rotate

Allows you to rotate the active content on the screen. The rotate feature includes:

Twist – Allows you to rotate active content in 90° increments using two fingers where one finger is anchored and the other rotates.



Keeping the thumb in place, move the index finger in an arced direction right or left to rotate the selected item 90° clockwise or counterclockwise.

Desktop

Allows you to minimize all open windows so that the desktop is visible.

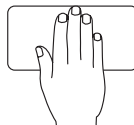

Place your hand on the touch pad in any orientation, briefly hold in place and then remove your hand.

Media Controls

The media controls can be accessed using the media control keys on the keyboard or the touch sensitive media controls located above the keyboard.

Media Control Keys

You can configure the keyboard media control keys using the **Function Key Behavior** in the **System Setup** (BIOS) utility. The options in the **Function Key Behavior** setting are:

Multimedia Key First – This is the default setting. Pressing any media control key performs the associated multimedia action. For function key, press <Fn> + the required function key.

Function Key First – Pressing any function key performs the associated function. For multimedia action, press <Fn> + the required media control key.



NOTE: The **Multimedia Key First** option is active only in the operating system.

Touch Sensitive Media Controls

Touching the media control performs the associated multimedia action.

Media Control Keys



Touch Sensitive Media Controls



 Launch Windows Mobility Center

 Mute the sound

 Decrease the volume level

 Increase the volume level

 Play the previous track or chapter

 Play or pause

 Play the next track or chapter

 Eject the disc

Display Features

The display panel holds a camera and accompanying dual microphones.

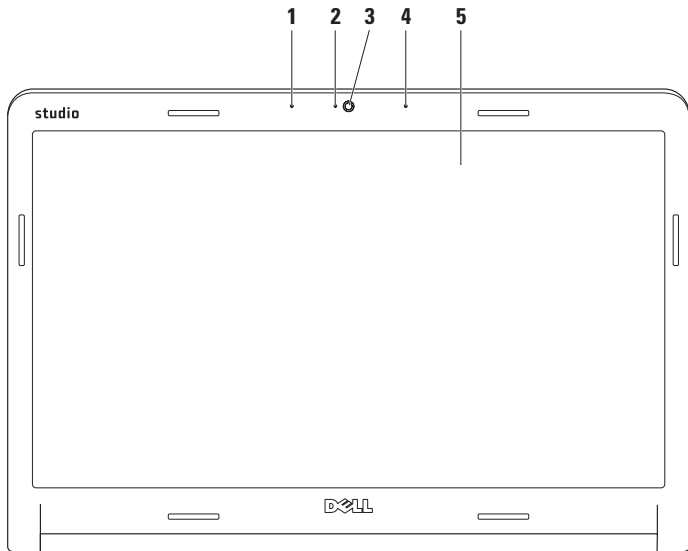

-
- 1 Left digital array microphone** – Combines with the right digital array microphone to provide high quality sound for video chatting and voice recording.

 - 2 Camera activity indicator** – Indicates if the camera is on or off.

 - 3 Camera** – Built-in camera for video capture, conferencing, and chat.

 - 4 Right digital array microphone** – Combines with the left digital array microphone to provide high quality sound for video chatting and voice recording.

 - 5 Display** – Your display can vary based on selections you made when purchasing your computer. For more information about displays, see the *Dell Technology Guide*.
-

Using the Touch Screen (Optional)

The touch screen feature on your Studio laptop converts your computer into an interactive display.

Dell Touch Zone

To launch the Dell Touch Zone software click **Start**  → **Dell Touch Zone**.

You can access the following features in the Dell Touch Zone software:

- **Picture Viewer** — View, organize, and edit pictures.
- **Dell Touch Cam** — Capture home videos with the built-in camera. You can upload videos to **YouTube** when connected to the Internet.

- **Notes Creator** — Create typed or handwritten reminders. These notes will appear on the bulletin board the next time you access Dell Touch Zone.
 - **Drum Zone** — Play a game to the music on your computer or play synthesized percussion instruments.
 - **You Paint** — Draw, paint images, and edit photographs using this software.
 - **Games** — Play select Windows games using touch.
 - **Music** — Play music, create play lists, and browse through your music files by album, artist, or song title.
 - **Internet Explorer** — Browse the Internet using multi-touch technology. Touch a link you want to follow or download.
 - **Help** — Use the Help feature for more information on how to use the touch screen.
- A video highlighting the features of the touch screen launches the first time your computer starts up.

Touch Screen Gestures (Optional)

 **NOTE:** Some of these gestures may not work outside the Dell Touch Zone software.

Zoom

Allows you to increase or decrease the magnification of the screen content.

Pinch – Allows you to zoom in or zoom out by moving two fingers apart or bringing them closer together on the screen.



To zoom in: Move two fingers apart to enlarge the view of the active window.



To zoom out: Move two fingers close together to reduce the view of the active window.

Dwell

Allows you to access additional information by simulating a right-click.

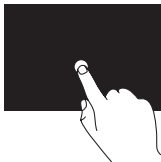

Press and hold a finger on the touch screen, to open context-sensitive menus.

Flick

Allows you to flip content forward or backward based on the direction of the flick.

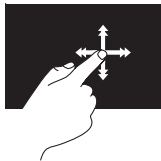

Move a finger quickly in the desired direction to flip through content in the active window like pages in a book. Flick also works vertically when navigating content such as images or songs in a playlist.

Scroll

Allows you to scroll through content. The scroll features include:

Pan – Allows you to move the focus on the selected object when the entire object is not visible.

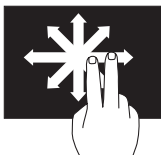

Move two fingers in the desired direction to pan scroll the selected object.

Scroll Vertical – Allows you to scroll up or scroll down on the active window.

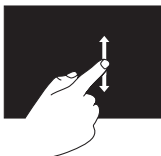

Move a finger up or down to activate vertical scrolling.

Scroll Horizontal – Allows you to scroll left or right on the active window.

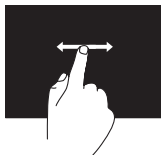

Move a finger to the left or right to activate horizontal scrolling.

Rotate

Allows you to rotate the active content on the screen.

Twist – Allows you to rotate the active content in 90° increments using two fingers.



Keeping a finger or thumb in place, move the other finger in an arced direction right or left. You can also rotate the active content by moving both the fingers in a circular motion.

Removing and Replacing the Battery

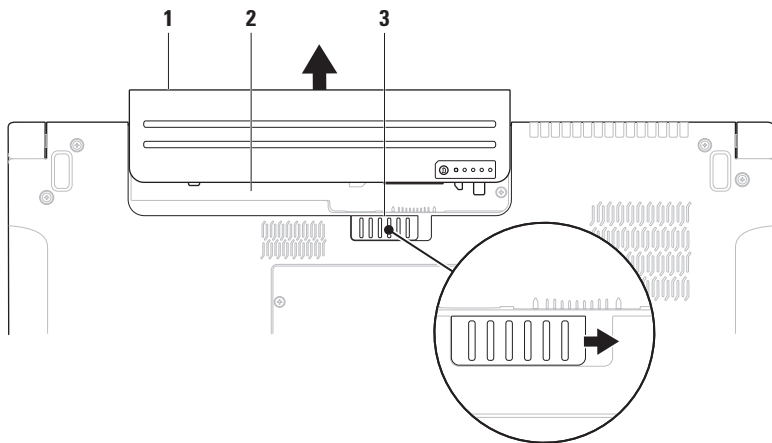

1 battery

2 battery bay

3 battery release latch

 **WARNING: Using an incompatible battery may increase the risk of fire or explosion. This computer should only use a battery purchased from Dell. Do not use batteries from other computers.**

 **WARNING: Before removing the battery, shut down the computer, and remove external cables (including the AC adapter).**

To remove the battery:

1. Shut down the computer and turn it over.
2. Slide the battery release latch to the side.
3. Slide the battery away from the battery bay.

To replace the battery:

Slide the battery into the battery bay, until it clicks into place.

Software Features

 **NOTE:** For more information about the features described in this section, see the *Dell Technology Guide* on your hard drive or on the Dell Support website at support.dell.com.

FastAccess facial recognition

Your computer may have the FastAccess facial recognition feature. This feature helps keep your Dell computer secure by learning the unique appearance of your face and uses this to verify your identity to automatically supply login information when you would normally enter this information yourself (such as for logging into a Windows account or into secure websites). For more information, click

Start  → **Programs** → **FastAccess**

Productivity and Communication

You can use your computer to create presentations, brochures, greeting cards, fliers, and spreadsheets. You can also edit and view digital photographs and images. Check your purchase order for software installed on your computer.

After connecting to the Internet, you can access websites, setup an e-mail account, upload and download files, and so on.

Entertainment and Multimedia

You can use your computer to watch videos, play games, create your own CDs/DVDs, listen to music and internet radio stations. Your optical disc drive may support multiple disc media formats including CDs, DVDs, and Blu-ray Discs (optional).

You can download or copy pictures and video files from portable devices, such as digital cameras and cell phones. Optional software applications enable you to organize and create music and video files that can be recorded to disc, saved on portable products such as MP3 players and handheld entertainment devices, or played and viewed directly on connected TVs, projectors, and home theater equipment.

Customizing the Desktop

You can use the customizing options available in your operating system to change the appearance, resolution, wallpaper, screensaver, and so on.

Windows Vista[®]

1. Right-click an open area of the desktop.
2. Click **Personalize**, to open the **Personalize appearance and sounds** window and learn more about your customization options.

Windows[®] 7

1. Right-click an open area of the desktop.
2. Click **Personalize**, to open the **Change the visuals and sounds on your computer** window and learn more about your customization options.

Customizing Your Energy Settings

You can use the power options in your operating system to configure the power settings on your computer. Microsoft® Windows® operating system installed on your Dell computer provides three default options:

Windows Vista®

- **Dell Recommended** — This power option offers full performance when you need it and saves power during periods of inactivity.
- **Power saver** — This power option saves power on your computer by reducing system performance to maximize the life of the computer and by reducing the amount of energy consumed by your computer over its lifetime.

- **High performance** — This power option provides the highest level of system performance on your computer by adapting processor speed to your activity and by maximizing system performance.

Windows® 7

- **Power saver** — This power option saves power on your computer by reducing system performance to maximize the life of the computer and by reducing the amount of energy consumed by your computer over its lifetime.
- **Balanced (recommended)** — This power option automatically balances the performance of your computer by consuming energy on capable hardware.

Transferring Information to a New Computer

Windows Vista[®]

 **NOTE:** The following steps are applicable for the Windows default view, so they may not apply if you set your Dell™ computer to the Windows Classic view.

1. Click **Start**  → **Control Panel** → **System and Maintenance** → **Welcome Center** → **Transfer files and settings**.

If the **User Account Control** window appears, click **Continue**.

2. Follow the instructions on the **Windows Easy Transfer** wizard.

Windows[®] 7

1. Click **Start**  → **Control Panel** → **Getting Started** → **Transfer files from another computer**.
2. Follow the instructions on the **Windows Easy Transfer** wizard.

Backing Up Your Data

It is recommended that you periodically back up files and folders on your computer. To back up files:

Windows Vista[®]

1. Click **Start**  → **Control Panel** → **System and Maintenance** → **Back Up and Restore Center** → **Back up files**.

If the **User Account Control** window appears, click **Continue**.

 **NOTE:** Certain editions of Windows Vista provide an option to back up your computer.

2. Follow the instructions on the **Back Up Files** wizard.

Windows[®] 7

1. Click **Start**  → **Control Panel** → **Back Up and Restore**.
2. Click **Set up backup....**
3. Follow the instructions on the **Configure Backup** wizard.

Free Fall Sensor

Free fall sensor protects your computer hard drive from possible damage, by detecting a free fall state caused by accidental laptop drops. When a free fall state is detected, the hard drive is placed in a *safe state* to protect against damage to the read/write head and possible data loss. Your hard drive returns to normal operation, when the free fall state is no longer detected.

Solving Problems

This section provides troubleshooting information for your computer. If you cannot solve your problem using the following guidelines, see “Using Support Tools” on page 52 or “Contacting Dell” on page 73.

 **WARNING: Only trained service personnel should remove the computer cover. See the *Service Manual on the Dell Support website at support.dell.com for advanced service and troubleshooting instructions.***

Touch Screen Problems

Some or all multi-touch features are not working —

- Certain multi-touch features may be disabled. To enable multi-touch features, click the **Multi-touch settings** icon in the system tray.
- Certain touch screen features may be disabled. To enable the touch screen

features, click **Start**  → **Control Panel** → **Pen and Input Devices**.

- The multi-touch feature may not be supported by the application.

If the touch screen starts losing its sensitivity

— The touch screen may have foreign particles (such as sticky notes) that are blocking the touch sensors. To remove these particles:

1. Turn off the computer.
2. Disconnect the power cord from the wall outlet.

 **CAUTION: Do not use water or a cleaning liquid to wipe the touch screen.**

3. Use a clean, lint-free cloth (can spray mild, non abrasive cleaner or water on cloth if needed, but not on screen) and wipe the surface and sides of the touch screen to remove any dirt or fingerprints.

Beep Codes

Your computer might emit a series of beeps during start-up if the monitor cannot display errors or problems. The following repetitive beep codes help you troubleshoot problems with your computer.

 **NOTE:** To replace parts, see the *Service Manual* on the Dell Support website at support.dell.com.

One beep — *BIOS ROM checksum failure; Possible motherboard failure*

Contact Dell (see “Contacting Dell” on page 73).

Two beeps — *No RAM Detected*

- Remove the memory modules, reinstall one module and restart the computer. If the computer starts normally, reinstall an additional module. Continue until you have identified a faulty module or reinstalled all modules without an error.
- If available, install memory modules of the same type in your computer.

- If the problem persists, contact Dell (see “Contacting Dell” on page 73).

Three beeps — *Possible motherboard failure*

Contact Dell (see “Contacting Dell” on page 73).

Four beeps — *RAM read/write failure*

- Ensure that no special memory module/memory connector placement requirements exist (see the *Service Manual* on the Dell Support website at support.dell.com).
- Verify that the memory modules that you are installing are compatible with your computer. For more information about the type of memory supported by your computer, see “Specifications” on page 76.
- If the problem persists, contact Dell (see “Contacting Dell” on page 73).

Five beeps — *Real Time Clock failure*

Replace the battery.

Six beeps — *Video card or chip failure*

Contact Dell (see “Contacting Dell” on page 73).

Seven beeps — *Processor failure*

Contact Dell (see “Contacting Dell” on page 73).

Eight beeps — *Display failure*

Contact Dell (see “Contacting Dell” on page 73).

Network Problems

Wireless Connections

If the wireless network connection is lost —

The wireless router is offline or wireless has been disabled on the computer.

- Check your wireless router to ensure it is powered on and connected to your data source (cable modem or network hub).
- Interference may be blocking or interrupting your wireless connection. Try moving the computer closer to your wireless router.
- Re-establish your connection to the wireless router (see “Setting Up a Wireless Connection” on page 15).

Wired Connections

If the wired network connection is lost — The cable is loose or damaged.

- Check the cable to ensure it is plugged in and not damaged.

The link integrity light on the integrated network connector lets you verify that your connection is working and provides information on the status:

- Green — A good connection exists between a 10-Mbps network and the computer.
- Orange — A good connection exists between a 100/1000-Mbps network and the computer.
- Off — The computer is not detecting a physical connection to the network.

 **NOTE:** The link integrity light on the network connector is only for the wired network connection. The link integrity light does not provide status for wireless connections.

Power Problems

If the power light is off — The computer is either turned off or is not receiving power.

- Reseat the power cable into both the power connector on the computer and the electrical outlet.
- If the computer is plugged into a power strip, ensure that the power strip is plugged into an electrical outlet and that the power strip is turned on. Also bypass power protection devices, power strips, and power extension cables to verify that the computer turns on properly.
- Ensure that the electrical outlet is working by testing it with another device, such as a lamp.
- Check the AC adapter cable connections. If the AC adapter has a light, ensure that the light on the AC adapter is on.

If the power light is solid white and the computer is not responding — The display may not be responding. Press the power button until the computer turns off and then turn it back on.

If the power light is blinking white — The computer is in standby mode. Move the pointer using the connected mouse or press the power button to resume normal operation.

If you encounter interference that hinders reception on your computer — An unwanted signal is creating interference by interrupting or blocking other signals. Some possible causes of interference are:

- Power, keyboard, and mouse extension cables.
- Too many devices connected to a power strip.
- Multiple power strips connected to the same electrical outlet.

Memory Problems

If you receive an insufficient memory message —

- Save and close any open files and exit any open programs you are not using to see if that resolves the problem.
- See the software documentation for minimum memory requirements. If necessary, install additional memory (see the *Service Manual* on the Dell Support website at **support.dell.com**).
- Reseat the memory modules (see the *Service Manual* on the Dell Support website at **support.dell.com**) to ensure that your computer is successfully communicating with the memory.

If you experience other memory problems —

- Ensure that you are following the memory installation guidelines (see the *Service Manual* on the Dell Support website at **support.dell.com**).
- Check if the memory module is compatible with your computer. Your computer supports DDR3 memory. For more information about the type of memory supported by your computer, see “Specifications” on page 76.
- Run the Dell Diagnostics (see “Dell Diagnostics” on page 56).
- Reseat the memory modules (see the *Service Manual* on the Dell Support website at **support.dell.com**) to ensure that your computer is successfully communicating with the memory.

Lockups and Software Problems

If the computer does not start up — Ensure that the power cable is firmly connected to the computer and to the electrical outlet.

If a program stops responding —

End the program:

1. Press <Ctrl><Shift><Esc> simultaneously.
2. Click **Applications**.
3. Click the program that is no longer responding
4. Click **End Task**.

If a program crashes repeatedly — Check the software documentation. If necessary, uninstall and then reinstall the program.

 **NOTE:** Software usually includes installation instructions in its documentation or on the CD.

If the computer stops responding or a solid blue screen appears —



WARNING: You might lose data if you are unable to perform an operating system shutdown.

If you are unable to get a response by pressing a key on your keyboard or moving your mouse, press the power button for at least 8 to 10 seconds until the computer turns off and then restart your computer.

If a program is designed for an earlier Microsoft® Windows® operating system —

Run the Program Compatibility Wizard. The Program Compatibility Wizard configures a program so that it runs in an environment similar to an earlier version of Microsoft Windows operating system environments.

Windows Vista[®]

1. Click **Start**  → **Control Panel** → **Programs** → **Use an older program with this version of Windows**.
2. In the welcome screen, click **Next**.
3. Follow the instructions on the screen.

Windows[®] 7

1. Click **Start** .
2. In the search box, type `Use an older program with this version of Windows` and press <Enter>.
3. Follow the instructions on the **Program Compatibility** wizard.

If you have other software problems —

- Back up your files immediately.
- Use a virus-scanning program to check the hard drive or CDs.

- Save and close any open files or programs and shut down your computer through the **Start**  menu.
- Check the software documentation or contact the software manufacturer for troubleshooting information:
 - Ensure that the program is compatible with the operating system installed on your computer.
 - Ensure that your computer meets the minimum hardware requirements needed to run the software. See the software documentation for information.
 - Ensure that the program is installed and configured properly.
 - Verify that the device drivers do not conflict with the program.
 - If necessary, uninstall and then reinstall the program.

Using Support Tools

Dell Support Center

The **Dell Support Center** helps you find the service, support, and system-specific information you need.

To launch the application, click the  icon in the taskbar.

The **Dell Support Center** home page displays your computer's model number, service tag, express service code, and service contact information.

The home page also provides links to access:

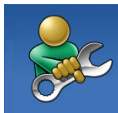

Self Help (Troubleshooting, Security, System Performance, Network/Internet, Backup/Recovery, and Windows operating system)



Alerts (technical support alerts relevant to your computer)



Assistance from Dell (Technical Support with DellConnect™, Customer Service, Training and Tutorials, How-To Help with Dell on Call, and Online Scan with PC CheckUp)



About Your System (System Documentation, Warranty Information, System Information, Upgrades & Accessories)

For more information about **Dell Support Center** and available support tools, click the **Services** tab at support.dell.com.

System Messages

If your computer has an issue or error, it may display a System Message that will help you identify the cause and action needed to resolve the issue.

 **NOTE:** If the message you received is not listed in the following examples, see the documentation for either the operating system or the program that was running when the message appeared. Alternatively you could see the *Dell Technology Guide* on your hard drive or on the Dell Support website at support.dell.com or see “Contacting Dell” on page 73 for assistance.

Alert! Previous attempts at booting this system have failed at checkpoint [nnnn]. For help in resolving this problem, please note this checkpoint and contact Dell Technical Support —

The computer failed to complete the boot routine three consecutive times for the same error. Contact Dell for assistance (see “Contacting Dell” on page 73).

CMOS checksum error — Possible motherboard failure or RTC battery low. Replace the battery (see the *Service Manual* on the Dell Support website at support.dell.com) or contact Dell (see “Contacting Dell” on page 73).

CPU fan failure — CPU fan has failed. Replace the CPU fan (see the *Service Manual* on the Dell Support website at support.dell.com).

Using Support Tools

Hard-disk drive failure — Possible hard disk drive failure during POST. Contact Dell for assistance (see “Contacting Dell” on page 73).

Hard-disk drive read failure — Possible hard disk drive failure during HDD boot test. Contact Dell for assistance (see “Contacting Dell” on page 73).

Keyboard failure — Keyboard failure or loose cable.

To replace the keyboard, see the *Service Manual* on the Dell Support website at support.dell.com.

No boot device available — No bootable partition on hard disk drive, the hard disk drive cable is loose, or no bootable device exists.

- If the hard drive is your boot device, ensure that the cables are connected and that the drive is installed properly and partitioned as a boot device.
- Enter system setup and ensure that the boot sequence information is correct (see the *Dell Technology Guide* on the Dell Support website at support.dell.com).

No timer tick interrupt — A chip on the system board might be malfunctioning or motherboard failure. Contact Dell for assistance (see “Contacting Dell” on page 73).

USB over current error — Disconnect the USB device. Your USB device needs more power for it to function properly. Use an external power source to connect the USB device, or if your device has two USB cables, connect both of them.

CAUTION - Hard Drive SELF MONITORING SYSTEM has reported that a parameter has exceeded its normal operating range. Dell recommends that you back up your data regularly. A parameter out of range may or may not indicate a potential hard drive problem — S.M.A.R.T error, possible hard disk drive failure. Contact Dell for assistance (see “Contacting Dell” on page 73).

Hardware Troubleshooter

If a device is either not detected during the operating system setup or is detected but incorrectly configured, you can use the **Hardware Troubleshooter** to resolve the incompatibility.

To start the Hardware Troubleshooter:

1. Click **Start**  → **Help and Support**.
2. Type `hardware troubleshooter` in the search field and press <Enter> to start the search.
3. In the search results, select the option that best describes the problem and follow the remaining troubleshooting steps.

Dell Diagnostics

If you experience a problem with your computer, perform the checks in “Lockups and Software Problems” on page 50 and run the Dell Diagnostics before you contact Dell for technical assistance.

 **NOTE:** Dell Diagnostics works only on Dell computers.

 **NOTE:** The *Drivers and Utilities* disc is optional and may not ship with your computer.

See the *Dell Technology Guide* to review your computer’s configuration information, and ensure that the device that you want to test appears in the system setup program and is active.

Start the Dell Diagnostics from your hard drive or from the *Drivers and Utilities* disc.

Starting Dell Diagnostics From Your Hard Drive

The Dell Diagnostics is located on a hidden diagnostic utility partition on your hard drive.

 **NOTE:** If your computer cannot display a screen image, contact Dell (see “Contacting Dell” on page 73).

1. Ensure that the computer is connected to an electrical outlet that is known to be working properly.
2. Turn on (or restart) your computer.
3. When the DELL™ logo appears, press <F12> immediately. Select **Diagnostics** from the boot menu and press <Enter>.

 **NOTE:** If you wait too long and the operating system logo appears, continue to wait until you see the Microsoft® Windows® desktop; then, shut down your computer and try again.

 **NOTE:** If you see a message stating that no diagnostics utility partition has been found, run the Dell Diagnostics from the *Drivers and Utilities* disc.

If PSA is invoked:

- a. The PSA starts running tests.
- b. If the PSA completes successfully, you will receive the following message:
"No problems have been found with this system so far. Do you want to run the remaining memory tests? This will take about 30 minutes or more. Do you want to continue? (Recommended)."

- c. Press <y> to continue if you are experiencing memory issues, else press <n>.
- d. You will receive the message "Booting Dell Diagnostic Utility Partition. Press any key to continue."
- e. Press any key to go to the **Choose An Option** window.

If PSA is not invoked:

Press any key to start the Dell Diagnostics from the diagnostics utility partition on your hard drive.

4. Select the test you want to run.

Using Support Tools

5. If a problem is encountered during a test, a message appears with an error code and a description of the problem. Write down the error code and problem description and contact Dell (see “Contacting Dell” on page 73).
 **NOTE:** The Service Tag for your computer is located at the top of each test screen. If you contact Dell, technical support will ask for your Service Tag.
6. When the tests are complete, close the test screen to return to the **Choose An Option** window. To exit the Dell Diagnostics and to restart the computer, click **Exit**.

Starting Dell Diagnostics From the Drivers and Utilities Disc

1. Insert the *Drivers and Utilities* disc.
2. Shut down and restart the computer. When the DELL logo appears, press <F12> immediately.

 **NOTE:** If you wait too long and the operating system logo appears, continue to wait until you see the Microsoft® Windows® desktop; then, shut down your computer and try again.

 **NOTE:** The next steps change the boot sequence for one time only. On the next start-up, the computer boots according to the devices specified in the system setup program.

3. When the boot device list appears, highlight **CD/DVD/CD-RW** and press <Enter>.
4. Select the **Boot from CD-ROM** option from the menu that appears and press <Enter>.
5. Type 1 to start the CD menu and press <Enter> to proceed.
6. Select **Run the 32 Bit Dell Diagnostics** from the numbered list. If multiple versions are listed, select the version appropriate for your computer.
7. Select the test you want to run.
8. If a problem is encountered during a test, a message appears with an error code and a description of the problem. Write down the error code and problem description and contact Dell (see “Contacting Dell” on page 73).

 **NOTE:** The Service Tag for your computer is located at the top of each test screen. If you contact Dell, technical support will ask for your Service Tag.

9. When the tests are complete, close the test screen to return to the **Choose An Option** window. To exit the Dell Diagnostics and restart the computer, click **Exit**.
10. Remove the *Drivers and Utilities* disc.

Restoring Your Operating System

You can restore your operating system in the following ways:

- System Restore returns your computer to an earlier operating state without affecting data files. Use System Restore as the first solution for restoring your operating system and preserving data files.
- Dell Factory Image Restore returns your hard drive to the operating state it was in when you purchased the computer. This procedure permanently deletes all data on the hard drive and removes any programs installed after you received the computer. Use Dell Factory Image Restore only if System Restore did not resolve your operating system problem.
- If you received an Operating System disc with your computer, you can use it to restore your operating system. However, using the Operating System disc also deletes all data on the hard drive. Use the disc only if System Restore did not resolve your operating system problem.

System Restore

The Windows operating systems provide a System Restore option which allows you to return your computer to an earlier operating state (without affecting data files) if changes to the hardware, software, or other system settings have left the computer in an undesirable operating state. Any changes that System Restore makes to your computer are completely reversible.

 **CAUTION:** Make regular backups of your data files. System Restore does not monitor your data files or recover them.

 **NOTE:** The procedures in this document are applicable for the Windows default view, so they may not apply if you set your Dell™ computer to the Windows Classic view.

Starting System Restore

1. Click **Start** .
2. In the search box, type `System Restore` and press <Enter>.

 **NOTE:** The **User Account Control** window may appear. If you are an administrator on the computer, click **Continue**; otherwise, contact your administrator to continue the desired action.

3. Click **Next** and remaining prompts on the screen.

In the event that System Restore did not resolve the issue, you may undo the last system restore.

Undoing the Last System Restore

 **NOTE:** Before you undo the last system restore, save and close all open files and exit any open programs. Do not alter, open, or delete any files or programs until the system restoration is complete.

1. Click **Start** .
2. In the search box, type `System Restore` and press <Enter>.
3. Click **Undo my last restoration** and click **Next**.

Dell Factory Image Restore



WARNING: Using Dell Factory Image Restore permanently deletes all data on the hard drive and removes any programs or drivers installed after you received your computer. If possible, back up the data before using this option. Use Dell Factory Image Restore only if System Restore did not resolve your operating system problem.



NOTE: Dell Factory Image Restore may not be available in certain countries or on certain computers.

Use Dell Factory Image Restore only as the last method to restore your operating system. This option restores your hard drive to the operating state it was in when you purchased the computer. Any programs or files added since you received your computer—including data files—are permanently deleted from the hard drive. Data files include documents, spreadsheets, e-mail messages, digital photos, music files, and so on. If possible, back up all data before using Dell Factory Image Restore.

Starting Dell Factory Image Restore

1. Turn on the computer. When the Dell logo appears, press <F8> several times to access the **Advanced Boot Options** window.

 **NOTE:** If you wait too long and the operating system logo appears, continue to wait until you see the Microsoft® Windows® desktop; then, shut down your computer and try again.

2. Select **Repair Your Computer**.
3. The **System Recovery Options** window appears.
4. Select a keyboard layout and click **Next**.
5. To access the recovery options, log on as a local user. To access the command prompt, type `administrator` in the **User name** field, then click **OK**.
6. Click **Dell Factory Image Restore**. The **Dell Factory Image Restore** welcome screen appears.

 **NOTE:** Depending upon your configuration, you may need to select **Dell Factory Tools**, then **Dell Factory Image Restore**.

7. Click **Next**. The **Confirm Data Deletion** screen appears.

 **NOTE:** If you do not want to proceed with Factory Image Restore, click **Cancel**.

8. Select the checkbox to confirm that you want to continue reformatting the hard drive and restoring the system software to the factory condition, then click **Next**.

The restore process begins and may take five or more minutes to complete. A message appears when the operating system and factory-installed applications have been restored to factory condition.

9. Click **Finish** to reboot the system.

Operating System Reinstallation

Before you Begin

If you are considering reinstalling the Windows operating system to correct a problem with a newly installed driver, first try using Windows Device Driver Rollback. If Device Driver Rollback does not resolve the problem, then use System Restore to return your operating system to the operating state it was in before you installed the new device driver. See “System Restore” on page 61.

 **CAUTION:** Before performing the installation, back up all data files on your primary hard drive. For conventional hard drive configurations, the primary hard drive is the first drive detected by the computer.

To reinstall Windows, you need the following:

- Dell *Operating System* disc
- Dell *Drivers and Utilities* disc





NOTE: The *Drivers and Utilities* disc contains drivers that were installed during the assembly of the computer. Use the Dell *Drivers and Utilities* disc to load any required drivers. Depending on the region from which you ordered your computer, or whether you requested the disc, the Dell *Drivers and Utilities* disc and *Operating System* disc may not ship with your computer.

Reinstalling Microsoft Windows

The reinstallation process can take 1 to 2 hours to complete. After you reinstall the operating system, you must also reinstall the device drivers, virus protection program, and other software.

1. Save and close any open files and exit any open programs.
2. Insert the *Operating System* disc.
3. Click **Exit** if the **Install Windows** message appears.
4. Restart the computer.
5. When the DELL logo appears, press <F12> immediately.

 **NOTE:** If you wait too long and the operating system logo appears, continue to wait until you see the Microsoft® Windows® desktop; then, shut down your computer and try again.

 **NOTE:** The next steps change the boot sequence for one time only. On the next start-up, the computer boots according to the devices specified in the system setup program.

6. When the boot device list appears, highlight **CD/DVD/CD-RW Drive** and press <Enter>.
7. Press any key to **Boot from CD-ROM**. Follow the instructions on the screen to complete the installation.

Getting Help

If you experience a problem with your computer, you can complete the following steps to diagnose and troubleshoot the problem:

1. See “Solving Problems” on page 45 for information and procedures that pertain to the problem your computer is experiencing.
2. See the *Dell Technology Guide* for more troubleshooting information.
3. See “Dell Diagnostics” on page 56 for procedures on how to run Dell Diagnostics.
4. Fill out the “Diagnostic Checklist” on page 72.
5. Use Dell’s extensive suite of online services available at Dell Support (support.dell.com) for help with installation and troubleshooting procedures. See “Online Services” on page 68 for a more extensive list of Dell Support online.

6. If the preceding steps have not resolved the problem, see “Before You Call” on page 71.

 **NOTE:** Call Dell Support from a telephone near or at the computer so that the support staff can assist you with any necessary procedures.

 **NOTE:** Dell’s Express Service Code system may not be available in all countries.

When prompted by Dell’s automated telephone system, enter your Express Service Code to route the call directly to the proper support personnel. If you do not have an Express Service Code, open the **Dell Accessories** folder, double-click the **Express Service Code** icon, and follow the directions.

 **NOTE:** Some of the services are not always available in all locations outside the continental U.S. Call your local Dell representative for information on availability.

Technical Support and Customer Service

Dell's support service is available to answer your questions about Dell hardware. Our support staff use computer-based diagnostics to provide fast, accurate answers.

To contact Dell's support service, see "Before You Call" on page 71 and then see the contact information for your region or go to **support.dell.com**.

DellConnect™

DellConnect is a simple online access tool that allows a Dell service and support associate to access your computer through a broadband connection, diagnose your problem and repair it all under your supervision. For more information, go to **www.dell.com/dellconnect**.

Online Services

You can learn about Dell products and services on the following websites:

- **www.dell.com**
- **www.dell.com/ap** (Asian/Pacific countries only)
- **www.dell.com/jp** (Japan only)
- **www.euro.dell.com** (Europe only)
- **www.dell.com/la** (Latin American and Caribbean countries)
- **www.dell.ca** (Canada only)

You can access Dell Support through the following websites and e-mail addresses:

Dell Support websites

- **support.dell.com**
- **support.jp.dell.com** (Japan only)
- **support.euro.dell.com** (Europe only)
- **supportapj.dell.com** (Asia Pacific only)

Dell Support e-mail addresses

- **mobile_support@us.dell.com**
- **support@us.dell.com**
- **la-techsupport@dell.com** (Latin America and Caribbean countries only)
- **apsupport@dell.com** (Asian/Pacific countries only)

Dell Marketing and Sales e-mail addresses

- **apmarketing@dell.com** (Asian/Pacific countries only)
- **sales_canada@dell.com** (Canada only)

Anonymous file transfer protocol (FTP)

- **ftp.dell.com**
Log in as user: `anonymous`, and use your e-mail address as your password.

Automated Order-Status Service

To check on the status of any Dell products that you have ordered, you can go to **support.dell.com**, or you can call the automated order-status service. A recording prompts you for the information needed to locate and report on your order. For the telephone number to call your region, see “Contacting Dell” on page 73.

If you have a problem with your order, such as missing parts, wrong parts, or incorrect billing, contact Dell for customer assistance. Have your invoice or packing slip handy when you call. For the telephone number to call for your region, see “Contacting Dell” on page 73.

Product Information

If you need information about additional products available from Dell, or if you would like to place an order, visit the Dell website at **www.dell.com**. For the telephone number to call for your region or to speak to a sales specialist, see “Contacting Dell” on page 73.

Returning Items for Repair Under Warranty or for Credit

Prepare all items being returned, whether for repair or credit, as follows:

 **NOTE:** Before you return the product to Dell, make sure to back up any data on the hard drive and on any other storage device in the product. Remove any and all confidential, proprietary and personal information, as well as removable media, such as CDs and PC Cards. Dell is not responsible for any of your confidential, proprietary or personal information; lost or corrupted data; or damaged or lost removable media that may be included with your return.

1. Call Dell to obtain a Return Material Authorization Number, and write it clearly and prominently on the outside of the box.
2. For the telephone number to call for your region, see “Contacting Dell” on page 73.
3. Include a copy of the invoice and a letter describing the reason for the return.
4. Include a copy of the Diagnostics Checklist (see “Diagnostic Checklist” on page 72), indicating the tests that you have run and any error messages reported by the Dell Diagnostics (see “Dell Diagnostics” on page 56).
5. Include any accessories that belong with the item(s) being returned (power cables, software, guides, and so on) if the return is for credit.

6. Pack the equipment to be returned in the original (or equivalent) packing materials.

 **NOTE:** You are responsible for paying shipping expenses. You are also responsible for insuring any product returned, and you assume the risk of loss during shipment to Dell. Collect On Delivery (C.O.D.) packages are not accepted.

 **NOTE:** Returns that are missing any of the preceding requirements will be refused at Dell's receiving dock and returned to you.

Before You Call

 **NOTE:** Have your Express Service Code ready when you call. The code helps Dell's automated-support telephone system direct your call more efficiently. You may also be asked for your Service Tag (located on the back or bottom of your computer).

Remember to fill out the following Diagnostics Checklist. If possible, turn on your computer before you call Dell for assistance and call from a telephone at or near the computer. You may be asked to type some commands at the keyboard, relay detailed information during operations, or try other troubleshooting steps possible only at the computer itself. Ensure that the computer documentation is available.

Diagnostic Checklist

- Name:
- Date:
- Address:
- Phone number:
- Service Tag (bar code on the back or bottom of the computer):
- Express Service Code:
- Return Material Authorization Number (if provided by Dell support technician):
- Operating system and version:
- Devices:
- Expansion cards:
- Are you connected to a network? Yes/No
- Network, version, and network adapter:
- Programs and versions:

See your operating system documentation to determine the contents of the computer's start-up files. If the computer is connected to a printer, print each file. Otherwise, record the contents of each file before calling Dell.

- Error message, beep code, or diagnostic code:
- Description of problem and troubleshooting procedures you performed:

Contacting Dell

For customers in the United States, call 800-WWW-DELL (800-999-3355).

 **NOTE:** If you do not have an active Internet connection, you can find contact information on your purchase invoice, packing slip, bill, or Dell product catalog.

Dell provides several online and telephone-based support and service options. Availability varies by country and product, and some services may not be available in your area.

To contact Dell for sales, technical support, or customer service issues:

1. Visit **support.dell.com**.
2. Verify your country or region in the **Choose A Country/Region** drop-down menu at the bottom of the page.
3. Click **Contact Us** on the left side of the page.
4. Select the appropriate service or support link based on your need.
5. Choose the method of contacting Dell that is convenient for you.

Finding More Information and Resources

If you need to:

reinstall your operating system

run a diagnostic program for your computer, reinstall laptop system software, or update drivers for your computer, and readme files

learn more about your operating system, maintaining peripherals, RAID, Internet, Bluetooth®, networking, and e-mail

upgrade your computer with new or additional memory, or a new hard drive

reinstall or replace a worn or defective part

See:

the Operating System disc

the *Drivers and Utilities* disc



NOTE: Drivers and documentation updates can be found on the Dell™ Support website at **support.dell.com**.

the *Dell Technology Guide* installed on your hard drive

the *Service Manual* on the Dell Support website at **support.dell.com**



NOTE: In some countries, opening and replacing parts of your computer may void your warranty. Check your warranty and return policies before working inside your computer.

If you need to:

find safety best practices information for your computer

review Warranty information, Terms and Conditions (U.S. only), Safety instructions, Regulatory information, Ergonomics information, and End User License Agreement

find your Service tag/Express Service Code — You must use the service tag to identify your computer on **support.dell.com** or to contact technical support

find drivers and downloads
access technical support and product help
check on your order status for new purchases
find solutions and answers to common questions
locate information for last-minute updates about technical changes to your computer or advanced technical-reference material for technicians or experienced users

See:

the safety and regulatory documents that shipped with your computer and also see the Regulatory Compliance Homepage at **www.dell.com/regulatory_compliance**

the back or bottom of your computer



the Dell™ Support website at **support.dell.com**

Specifications

System Model

Dell Studio 1745/1747

This section provides information that you may need when setting up, updating drivers for, and upgrading your computer.

 **NOTE:** Offerings may vary by region. For more information regarding the configuration of your computer, click **Start**  → **Help and Support** and select the option to view information about your computer.

Processor

<i>Type</i>	<i>L2 cache</i>
Intel® Celeron®	1 MB
Intel Pentium® Dual-Core	1 MB
Intel Core™2 Duo	2 MB/3 MB/6 MB
Intel Core2 Quad	1 MB
L1 cache	128 KB for Dual-Core (Intel - 64 KB per core) 256 KB for Quad-Core (Intel - 64 KB per core)
L3 cache	8 MB for Quad-Core
External bus frequency	800/1066 MHz

Computer Information

System chipset	Mobile Intel Express GM 45
	Mobile Intel 5 Series Discrete GFX
Data bus width	64 bit
DRAM bus width	dual-channel (2) 64-bit buses
Processor address bus width	32 bits
Flash EPROM	2 MB
Graphics bus	PCI-E x16

ExpressCard

ExpressCard controller	Intel ICH9M
Cards supported	ExpressCard/34 (34 mm) 1.5 V and 3.3 V
ExpressCard connector size	26 pins

Specifications

Memory

Memory module connector	two user-accessible SODIMM connectors
Memory module capacities	1 GB, 2 GB, 4 GB
Memory type	1067/1333 MHz SODIMM DDR3
Minimum memory configuration	2 GB
Maximum memory configuration	8 GB

 **NOTE:** For instructions on upgrading memory, see the *Service Manual* on the Dell Support website at support.dell.com.

Connectors

Audio	one microphone-in connector, two stereo headphones/speakers connectors
IEEE 1394a	4-pin mini, non-powered connector
Mini-Card	one Type IIIA full Mini-Card slot, two half-size Mini-Card slots
HDMI connector	19-pin
Network adapter	RJ45 connector
USB	two four-pin USB 2.0-compliant connectors

Connectors

Video	15-hole connector
DisplayPort	20-pin connector
eSATA	one seven-pin/four-pin eSATA/USB combo connector

Communications

Modem (optional)	External V.92 56K USB Modem
Controller	Hardware Modem
Interface	USB
Network adapter	10/100/1000 Ethernet LAN on system board
Wireless	WLAN, WWAN, WiMax/Wi-Fi abgn/agn, and WPAN with Bluetooth® wireless technology

Video

<i>Discrete:</i>	
Video type	integrated on system board
Video controller	ATI Mobility Radeon HD 4570/4650
Video memory	DDR3 512 MB/1 GB
<i>UMA:</i>	
Video type	integrated on system board
Video controller	Mobile Intel GMA 4500MHD
Video memory	up to 358 MB of shared memory
LCD interface	Low Voltage Differential Signaling (LVDS)
TV support	HDMI 1.3

Specifications

Audio

Audio type	JBL 2.1 channel with SRS enhanced audio
Audio controller	IDT 92HD73C
Stereo conversion	24-bit (analog-to-digital and digital-to-analog)
Internal Interface	Intel High Definition Audio
Speaker	two 1.5 watt main speakers and one 3.0 watt subwoofer, for a total system power of 6.0 watt
Volume controls	program menus and media controls

Camera

Pixel	2.0 megapixel
Video Resolution	160 x 120 ~1600 x 1200 (160 x 120 ~ 1280 x 720 at 30 fps)
Diagonal Viewing Angle	60°

Display

Type	17.3" HD+ WLED backlight, TrueLife 17.3" FHD B+RG LED backlight, TrueLife
------	--

Display*Dimensions:*

Height	214.81 mm (8.46 inches)
Width	381.89 mm (15.04 inches)
Diagonal	439.42 mm (17.3 inches)
Maximum resolution	HD+: 1600 x 900 FHD: 1920 x 1080
Refresh rate	60 Hz
Operating angle	0° (closed) to 140°
Luminance	HD+: 220 nits FHD: 300 nits (both 72% and 90% CG)

Display*Viewing Angles:*

Horizontal	HD+: 40/40 FHD: 60/60 (both 72% and 90% CG)
Vertical	HD+: 15/30 (H/L) FHD: 50/50 (both 72% and 90% CG)
Pixel pitch	HD+: 0.24 x 0.24 mm FHD: 0.20 x 0.20 mm
Controls	brightness can be controlled through keyboard shortcuts (see the <i>Dell Technology Guide</i> for more information).

Specifications

Keyboard (Backlit)

Number of keys	102 (U.S. and Canada); 103 (Europe); 106 (Japan); 105 (Brazil)
Layout	QWERTY/AZERTY/Kanji

Touch Pad

X/Y position resolution (graphics table mode)	240 cpi
---	---------

Size:

Width	100-mm (3.9-inches) sensor-active area
Height	56-mm (2.2-inches) rectangle

Battery

Types and dimensions:

9-cell "smart" lithium ion

Depth	56.7 mm (2.23 inches)
Height	41.9 mm (1.65 inches)
Width	340.6 mm (13.41 inches)
Weight	0.52 kg (1.15 lb)

Battery

6-cell “smart” lithium ion	
Depth	56.7 mm (2.23 inches)
Height	22.2 mm (0.87 inches)
Width	206 mm (8.11 inches)
Weight	0.35 kg (0.77 lb)
Voltage	11.1 VDC (6/9 cell)
Charge time (approximate):	4 hours (when the computer is turned off)

Battery

Operating time	Battery operating time varies depending on operating conditions and can be significantly reduced under certain power-intensive conditions. See the <i>Dell Technology Guide</i> for more information on battery life.
Life span (approximate)	300 discharge/charge cycles
<i>Temperature range:</i>	
Operating	0° to 35°C (32° to 95°F)
Storage	–40° to 65°C (–40° to 149°F)
Coin-cell battery	CR-2032

Specifications

AC Adapter

Input voltage	100–240 VAC
Input current	1.5 A
Input frequency	50–60 Hz
Output power	65 W or 90 W
Output current	
65 W	4.43 A (maximum at 4-second pulse) 3.34 A (continuous)
90 W	5.62 A (maximum at 4-second pulse) 4.62 A (continuous)
Rated output voltage	19.5 ± 1 VDC

AC Adapter

Dimensions:

90 W (E-Series)

Height	16 mm (0.6 inches)
Width	70 mm (2.8 inches)
Depth	147 mm (5.8 inches)
Weight (with cables)	0.29 kg (0.64 lb)

90 W (D-Series)

Height	34.2 mm (1.3 inches)
Width	60.8 mm (2.3 inches)
Depth	153.4 mm (6.0 inches)
Weight (with cables)	0.46 kg (1.01 lb)

AC Adapter

65 W (Auto Air Adapter)	
Height	15 mm (0.5 inches)
Width	66 mm (2.6 inches)
Depth	127 mm (5.0 inches)
Weight (with cables)	0.26 kg (0.57 lb)
<i>Temperature range:</i>	
Operating	0° to 40°C (32° to 104°F)
Storage	-40° to 70°C (-40° to 158°F)

Physical

Height	28 mm to 40 mm (1.10 inches to 1.57 inches)
Width	413.0 mm (16.26 inches)
Depth	280.5 mm (11.04 inches)
Weight (with 6-cell battery)	configurable to less than 3.3 kg (7.27 lbs)

Specifications

Computer Environment

Temperature range:

Operating	0° to 35°C (32° to 95°F)
Storage	-40° to 65°C (-40° to 149°F)

Relative humidity (maximum):

Operating	10% to 90% (noncondensing)
Storage	5% to 95% (noncondensing)

Maximum vibration (using a random vibration spectrum that simulates user environment):

Operating	0.66 GRMS
Non-Operating	1.30 GRMS

Computer Environment

Maximum shock (for operating — measured with Dell Diagnostics running on the hard drive and a 2-ms half-sine pulse; for non-operating — measured with hard drive in head-parked position and a 2-ms half-sine pulse):

Operating	110 G
Non-Operating	160 G

Altitude (maximum):

Operating	-15.2 to 3048 m (-50 to 10,000 ft)
Storage	-15.2 to 10,668 m (-50 to 35,000 ft)
Airborne contaminant level	G2 or lower as defined by ISA-S71.04-1985

Appendix

Macrovision Product Notice

This product incorporates copyright protection technology that is protected by method claims of certain U.S. patents and other intellectual property rights owned by Macrovision Corporation and other rights owners. Use of this copyright protection technology must be authorized by Macrovision Corporation, and is intended for home and other limited viewing uses only unless otherwise authorized by Macrovision Corporation. Reverse engineering or disassembly is prohibited.

Index

A

airflow, allowing **5**

B

backups
 creating **43**

C

calling Dell **71**
CDs, playing and creating **41**
computer capabilities **40**
computer, setting up **5**
computer stand **6**
connect(ing)
 to the Internet **9**
conserving energy **42**

Contacting Dell online **73**
customer service **67**
customizing
 your desktop **41**
 your energy settings **42**

D

damage, avoiding **5**
data, backing up **43**
DellConnect **67**
Dell Diagnostics **56**
Dell Factory Image Restore **60**
Dell Support Center **52**
Dell support website **75**
Dell Technology Guide
 for further information **74**

Dell Touch Zone **34**
Diagnostic Checklist **71**
DisplayPort connector **23**
drivers and downloads **75**
DVDs, playing and creating **41**

E

email addresses
 for technical support **68**
energy
 conserving **42**

F

finding more information **74**
flick **36**
FTP login, anonymous **68**

G

gestures **36**

H

hardware problems
 diagnosing **55**
Hardware Troubleshooter **55**
help
 getting assistance and support **66**

I

installing the stand **6**
Internet connection **14**
ISP

 Internet Service Provider **14**

M

memory problems
 solving **49**

N

network connection

Index

fixing **47**

network speed

testing **47**

P

power problems, solving **48**

power strips, using **6**

problems, solving **45**

products

information and purchasing **69**

R

reinstalling Windows **60**

resources, finding more **74**

restoring factory image **62**

S

setup, before you begin **5**

shipping products

for return or repair **70**

SIM **10**

software features **40**

software problems **50**

solving problems **45**

specifications **76**

support email addresses **68**

support sites

worldwide **67**

System Messages **53**

system reinstall options **60**

System Restore **60**

T

Touch Pad

Gestures **28**

touch screen **34**

Gestures **36**

U

USB PowerShare **24**

V

ventilation, ensuring **5**

W

warranty returns **70**

Windows, reinstalling **60**

Windows Vista® **9**

 Program Compatibility Wizard **50**

 reinstalling **65**

wired network

 network cable, connecting **7**

wireless network connection **47**



Printed in the U.S.A.

www.dell.com | support.dell.com



OK027RA00